

---

# FRAUNHOFER IAPT

## WHAT WE DO / WHAT WE OFFER / WHAT WE LOOK FOR

Dipl.-Ing. Tim Wischeropp, HEAD OF DIVISION - AM Design

EPIC Online Technology Meeting on Industrial Laser Manufacturing for Naval and Aeronautic Applications

---



# MISSION STATEMENT FRAUNHOFER IAPT

## WHAT WE DO

### Mission

» Our mission is to industrialize Additive Manufacturing to create resource-efficient products for the future «

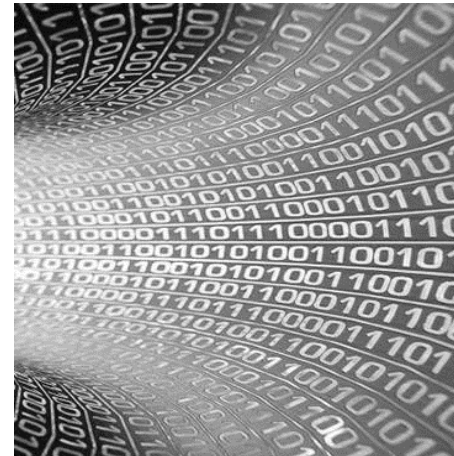
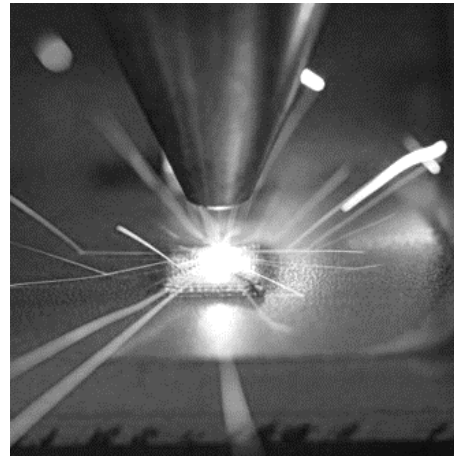
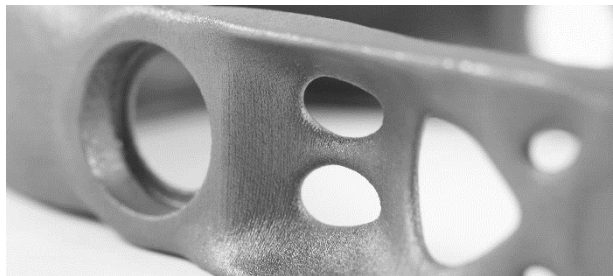
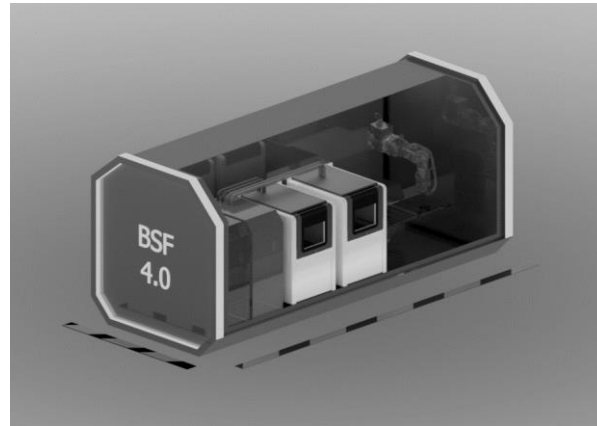

### Vision

» We are the leading institute for development of industrial solutions in Additive Manufacturing «

# WHAT WE OFFER

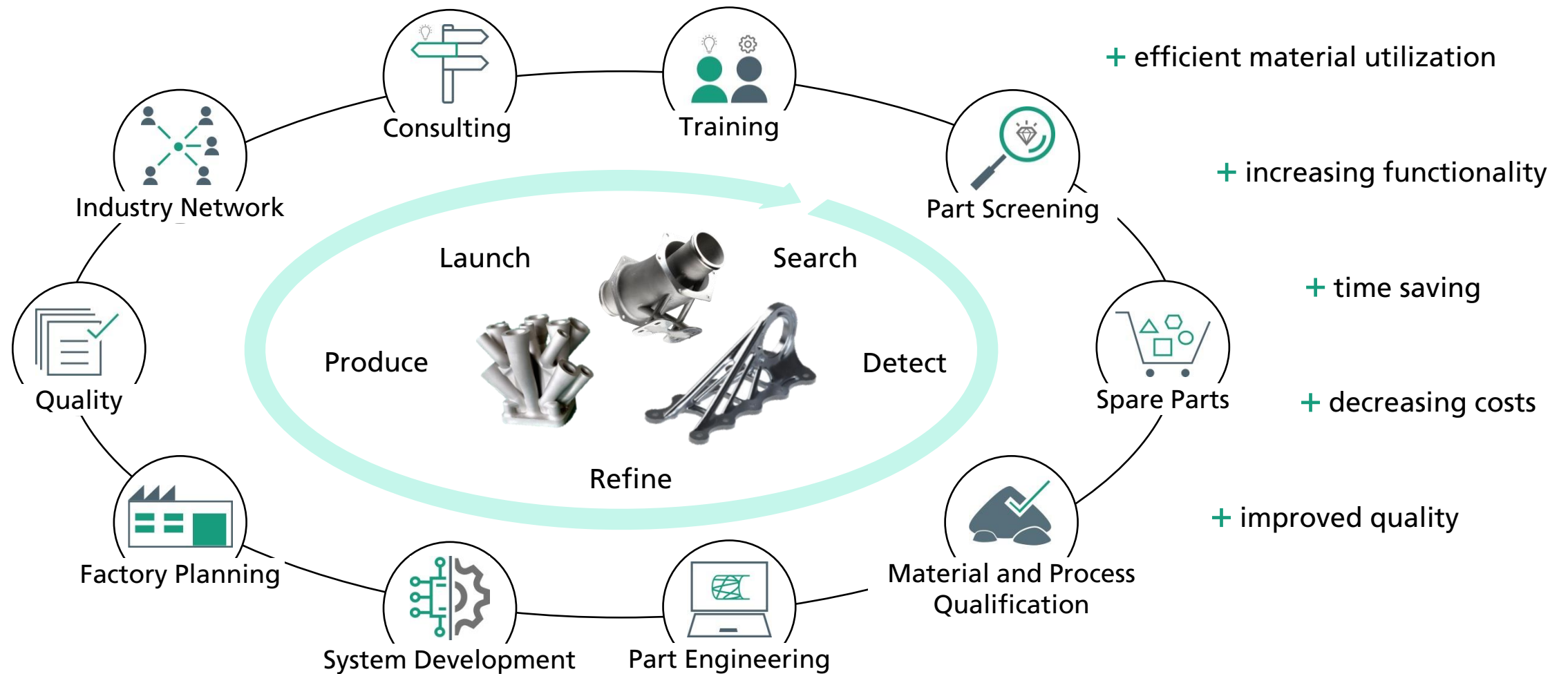

# WHAT WE OFFER - Functional Optimized Design (Examples)

## Cooling

- Oil-Water cooler for high performance motors



## Acoustic

- Additive manufactured muffler

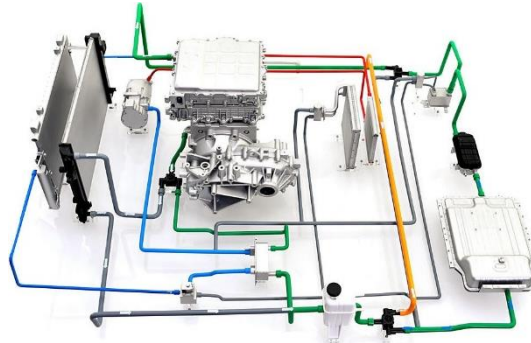

## Vibration

- Additive manufactured crank shaft

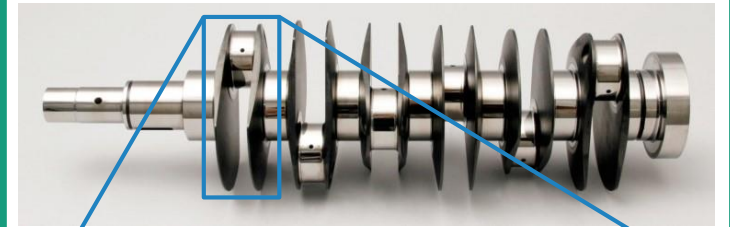

# WHAT WE LOOK FOR



## Partners for Cooperation



Companies looking to utilize and implement AM



Companies with special capabilities and products that help us to industrialize AM

- Lasers (ring mode / green lasers / ...)
- optics (beam shaping / low thermal shift / ...)
- Sensors that can be used for quality assurance in AM

### Beam Shaping

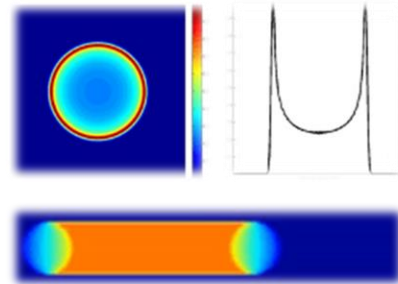

### Sensor



?

# Thank you for your attention!

## Contact

Dipl.-Ing. Tim Marten Wischeropp  
tim.wischeropp@iapt.fraunhofer.de  
Tel: +49 (0)40 48 40 10 722

**Fraunhofer IAPT**  
Am Schleusengraben 14  
21029 Hamburg, Germany

